



1st Quarter 2019



WORLD

YOUTH NEWSLETTER MODEL A FORD CLUB OF AMERICA

EASTER TIME

BY SHERRY WINK

The first spring flowers were just opening, and the trees were budding out. The whole countryside was turning green. It was going to be a beautiful Easter this year! On the Sitzman family homestead, excitement was in the air. The plans for Easter were in the works, and it was taking lots of work from everyone.

Dad Sitzman had a special ham curing in the smokehouse. He went out every so often and rubbed curing salt in it, and pronounced every time that it was going to be perfect just in time for Easter. Larry's mouth watered every time he heard that, thinking about how Grandma Roberts cooked it, with a blackstrap molasses glaze, baking for hours until the ham fell off the bone.

Both Grandma Roberts and Mom Sitzman had been saving eggs for the last month. Eggs at least two weeks old were best for making the boiled eggs that would be used to dye. According to Grandma Roberts, old eggs peeled better, and like always, Grandma knew her stuff!



The newer eggs were all now being kept separate for use for baking, and for the huge omelet that Mom Sitzman always served for breakfast on Easter. Mom and Grandma, and lots of the kids had been making cookies and cakes for the last several days to have for the big Easter meal where all the

relatives were coming over. It was hard to keep little hands from slipping under the dishtowels covering them and helping themselves to the cookies. Mom Sitzman didn't get too strict, but she made sure the majority of the goodies were out of reach just the same.

During the final week before Easter, Grandma Roberts had also come over to help make all the colors that were going to be used to dye the eggs. Grandma Roberts believed in doing this the old fashioned way. She said it made the eggs taste better, and the kids learned more from it! So the kitchen table was full of all the ingredients to make wonderful colors. The little kids had fun guessing what colors would come from which ingredients. Most of the older ones already knew!

Mom Sitzman had been saving onion skins for a while. Yellow onions made rusty orange eggs and beets turn eggs purple. Spinach made sense that it made a nice green, but it seemed strange to think that red cabbage made blue eggs and red onions made dark green eggs! And purple grape juice made light blue eggs. You could make pale green eggs with an extract of yellow apple skins, dill seed made a nice golden brown. And chamomile and green tea made some wonderful yellows. All of these items had to be boiled or steeped and usually mixed with vinegar to be ready to make the dyed eggs.



PAGE	TITLE
1	EASTER TIME
3	KIDS & THEIR A'S
4	THE STORY CONTINUES
5	FUN 1929 FACTS

PAGE	TITLE
6	SIX DIFFERENT THINGS
7	PASADENA HIGH SCHOOL CLUB RAFFLE
8.	MODEL A AD
9.	CARBURETOR BASICS
10	EASTER GREETINGS

PAGE	TITLE
10.	CARTOON
10	PUZZLE ANSWER
11	COLORING PAGE
12	RUMBLE SEAT
12	QUIZ

Finally, it was the Saturday before Easter, and there was a big pot of eggs steaming on the stove. Some of the natural dyes had to have the eggs soaked overnight and those eggs were the darkest, prettiest as far as Suzanne thought. The younger kids like Shannon and Nick liked the colors that you could dip the egg in for a few minutes and see the magic of the color changing. But light or dark, dozens of eggs finally rested in the refrigerator by the end of the day. Grandma Roberts had to take some home with her to put in her refrigerator, there were so many!

Sunday morning started with finding the Easter baskets hidden around the house for each kid. Each one has jelly beans, a chocolate bunny, and a small toy. But Mom Sitzman would only let each kid pick out one piece of candy to eat as it was time for breakfast!

It was time for the special omelet! The kids all looked forward to this each year! Mom Sitzman pulled out the big skillet that was as big around as a Model A wheel and covered most of the top of the kitchen stove. She would whip the eggs light and fluffy, and layer in mounds of bacon, onions, and cheese. Then, of course, there were also biscuits with homemade strawberry jelly. Yum!

After that, Dad Sitzman piled everyone into the Model A's (the pickup and Tudor) and everyone went to church wearing their best Easter hats and clothes. Each of the kids had a new outfit, and the older girls had new hats too. Following church, it was back to the farm to finish off the dinner!

The ham had been baking in the oven for hours by now, but there was plenty of other stuff to get ready. The boys gathered around the pump outside and started peeling mountains of potatoes. Suzanne headed to the garden to cut the fresh asparagus. Grandma Roberts took care of making fresh bread and Mom Sitzman pulled out the canned jars of green beans and tomatoes out of the fruit cellar. Everyone worked together and just in time the preparations were done as cars full of aunts and uncles and cousins started pulling into the driveway.

It was a great meal, but the kids were starting to get anxious by the time the last adult was done with the meal. Because that meant it was time for the Easter egg hunt! The kids that felt they were too old to be in the hunt quickly took off outside to hide the eggs. The younger kids waited anxiously until the all-clear was yelled. Then it was everyone for themselves, with baskets and buckets in every hand.

The adults all gathered around yelling encouragement. It was a sight to see! There were eggs everywhere! Up in trees, behind rocks, in the hay barn, and under the porch. Dad

Sitzman chuckled every time someone passed the purple egg sitting among the purple tulips. And Larry kept pointing out eggs to the little kids so they at least had a few in their basket. Who knows if they found them all, but if a few got missed, it didn't matter. What mattered was everyone had fun!

By the time the hunt was over, everyone was hungry again, so it was time for sandwiches and boiled eggs! And of course, time to share some Easter candy, and pull out the cookies and cakes. Shannon somehow ended up with the big chocolate egg that was supposed to be broken up among everyone. She enjoyed it until she was caught and made to take a quick bath!



Finally, it was time for the extended family to leave and their cars started pulling out one by one. But Uncle Pat's Model A just didn't want to start. He fooled around with the carburetor, and a few other things, and then finally tried again, really stomping on the gas pedal. And Whoosh, with a puff of smoke, and a crack as it hit the ground, the last Easter egg to find that day shot out of the tailpipe!

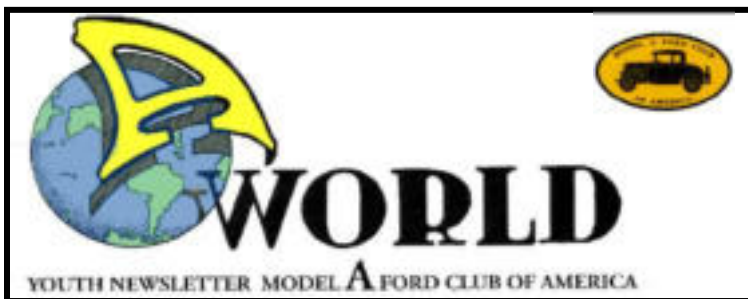

A-World is published by the Model A Ford Club of America for the benefit of youth and the promotion of the Model A hobby.



Editor: Sherry Winkinhofer
AWorldEditor@hotmail.com
© 2019 All Rights Reserved by

Model A Ford Club of America
250 South Cypress Street
La Habra CA 90631-5515

A-World is free, courtesy of MAFCA. As of May 2016, it became a web or email only publication. If you wish to have it emailed directly, please send your email address to AWorldEditor@hotmail.com

KIDS AND THEIR "A"s!



Jason LaPrise lives in Shelton Connecticut. He's proudly holding a trophy he won at the Newtown charity show.



Jasper Boshart is two years old and lives in Omaha Nebraska. While visiting his aunt, he found her recent copy of "The Restorer". He was thrilled to be able to take it home with him.



Garrett Losh, 13 years old, with his Tudor.



A new drawing by my nephew Carmen Cerra. He titled this "I'm too cool for this crowd ". Of course he is, he's driving a Model A!



12 year old Justin Ferguson in the family's '31 Victoria. Jason live in Temecula, California. He and his family are members of the Temecula Valley Model A Club. .

The Story Continues!

As narrated to Fred Kiehl (or so he says!)

This is the story of a rusted but running little Model A. In 1965, Fred bought me to fix up and use as his teenage car and. Well...and as happens with all renovations, the money didn't keep up with my needs. Then Fred met Sharon and work continued until...they got married and I was really put on the back, back burner. I languished in the garage until about 1985. New life was right around the corner! I was moved to Maysville and a mechanic was found who knew how to work on me. He got my engine running! Yippee! Then life happened again and Fred left me in storage until 2018. Enter my greatest fan, Alexander, the grandson

(He lets his sister, Emilie help). Now I've been washed, windshield installed and best of all, my engine runs! Next will be upholstery when Fred finds an upholsterer. Hope springs eternal.



Fun 1929 Facts

You know, the years 1928-1931 were not just about Model A's! Other things occurred in the world that also changed the way we live. Here's a few of them



The Edison Institute was dedicated by President Hoover on October 21, 1929 – the 50th anniversary of the first successful incandescent light bulb. Originally just a private site for educational purposes only, it proved so popular that it was opened to the public as “The Henry Ford” museum complex on June 22, 1933.



Popeye the Sailor made his first appearance in January 1929 in the comic strip “Thimble Theatre.” He proved to be such popular character that eventually the strip was renamed after him.



Wyatt Earp died in Los Angeles California on January 13, 1929. He was a colorful figure of the American West and one of the gunfighters at the famous shootout at the OK Corral, an event that has been recreated in dozens of movies and books. .



The first “Seeing Eye” guide dog school opened in Nashville Tn. Morris Frank, a young man blinded in WWI was inspired by reports of dogs being trained in Europe, and



When the soft drink 7 Up first launched in 1929 it contained lithium citrate, a drug now used to treat psychiatric issues. It wasn't taken out of the soft drink until 1950!

found an American working in Switzerland to help bring the training to the USA.



On October 29, 1929, Black Tuesday hit Wall Street. Billions of dollars were lost, more than the total cost of WWI. As a result, America and the rest of the industrialized world spiraled downward into the Great Depression which lasted for 10 years.

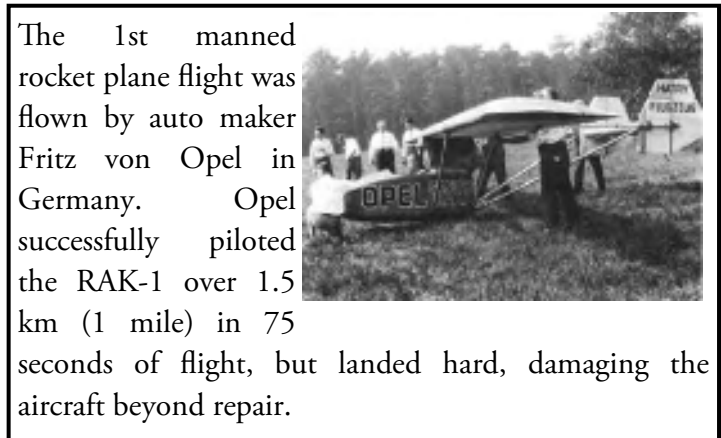

The 1st manned rocket plane flight was flown by auto maker Fritz von Opel in Germany. Opel successfully piloted the RAK-1 over 1.5 km (1 mile) in 75 seconds of flight, but landed hard, damaging the aircraft beyond repair.



The first Academy Awards were presented. The dog Rin Tin Tin received the most votes for best actor, but the academy decided it would be better to grant the award to a human.



The 96,000 acre Grand Teton National Park was established by President Coolidge.

Baseball Star Babe Ruth hit his 500th major league home run.



SIX THINGS ARE DIFFERENT!

Nate has this Model A is on it's way to being restored, but a few things in the top photo seem to have gotten lost. Can you find the missing details without looking at the answers? *The answers are on page 10 but don't peek too soon!*



THEY NEED YOUR SUPPORT! YOUTH CHAPTER SPOTLIGHT - PASADENA H.S.

(This article is directed at the adults reading this newsletter with their kids and grandkids!)

Here's a club doing it right in getting young people involved in our wonderful cars!! This MAFC club is actually located in a High School!! They have just restored their second car, and it's up for raffle. The money earned from this raffle goes back to the club to support their next project. What an amazing group!

This group needs your support to continue this mission. As of the time I heard from them, they had only sold 40% of the available tickets. Now I know this lowers my chances of winning, but that's ok! We all need to put

More info can be seen at: <https://www.youtube.com/watch?v=DYN8802yvrC&feature=youtu.be>

Pasadena High School Model A Ford Club Car Raffle, 2019

The Pasadena High School Model A Ford Club (PHSMAFC) is restoring a 1929 Model A Roadster to be given to one lucky family on April 20, 2019. That's right! One grand prizewinner will own a beautiful roadster restored by the only model a club located on any high school campus in the nation.



A Model A Roadster will find its new home in mere months

PHS club members begin as early as the ninth grade, potentially enjoying four years of hands-on membership. Students, who early on could not identify a screwdriver or wrench, now eagerly operate power tools. They understand the elements of the Model A engine, its interior, while preparing the car's body in preparation for paint. Participation is equally strong among both boys and girls, however our president and vice president just happen to be female.



PHS club members begin as early as the ninth grade enjoying four years of hands-on membership. Above students pose with the vehicle now being restored for its new home.

We need your help

Our club receives no funding from Pasadena School District, or any assistance from MAFC. We operate independently just as any other MAFC chapter. We rely deeply on our friends and contributors to support our annual raffle and car giveaway. This is our only source of income.



Students rebuilding a Model A transmission at facilities provided by our partner Pasadena Community College.

Each contributor will receive one raffle entry per one hundred dollars (\$100.00) contributed. Our odds of winning are quite favorable, limiting our entries to 750. Cash prizes will also be awarded. Previously many purchased multiple tickets, and for your generosity we express our gratitude.

Please forward your tax-deductible contribution to: PHSMAFC, 1968 Lake Ave, Suite 101, Altadena Ca. 91001, phsmafc@gmail.com. Kindly include a stamped, self-addressed envelope along with your phone number and email address. Please print clearly.

The winning ticket will be drawn at our "oldies" concert scheduled to occur 4/20/2019, featuring the "Platters." Ticket information for the concert will be included with your return raffle entry. Talent for the Las Vegas quality show will be donated by some of the best performers of our time. Raffle winner need not be present.



Students removing the engine prior to rebuild.

our money where our mouth is. We have long conversations about getting the kids involved, here it is in real life!

It's not too late to show your support! The winning ticket will be drawn April 20th. The ticket is tax deductible. Checks can be sent to PHSMAAFC, 168 Lake Ave, Suite 101, Altadena CA 91001. Please include a self-addressed stamped envelope. Please dig a little deep and support this amazing group of kids, and the adults that are hands-on working with the next generation of Model A owners!

Note: As your editor, I just want to assure you that I have no personal connections to this group. I found their flyer posted on MAFC Facebook and knew I had to pass the information along!



Carburetor Basics

Illustrations from <http://modelbasics.com>

The Model A carburetor is really an ingenious piece of equipment. It was built with multiple jets that work to distribute fuel to the motor according to gravity and the amount of air flowing through them. Suction is created by the pumping of the pistons and this causes gas and air to flow through the carburetor into the engine. Each jet handles fuel differently depending on the amount of fuel and air flowing in. But today, we are just covering the basics of a few easy to understand controls.

Throttle Plate

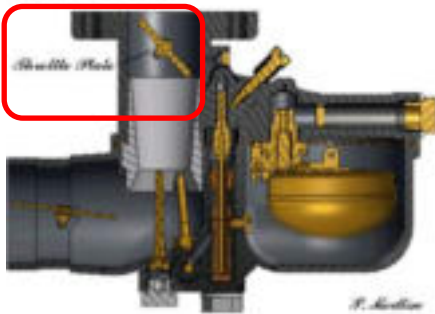

The throttle plate manages the amount of air flow that is delivered to the engine and is controlled by the (A) Throttle Lever and/or the (B) Accelerator inside the cab. That's the lever on the right side of the steering wheel and the gas pedal on the floor on the right of the driver's side.

Choke Plate

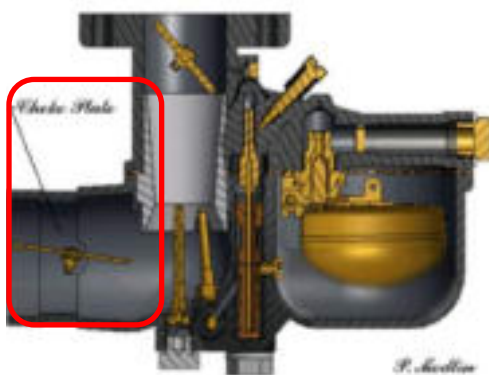

Pulling on the (C) Carburetor Adjustment Knob, (often called the GAV Gas Air Valve or the choke) inside the cab opens and closes the Choke Plate. Turning the GAV enriches or leans the fuel mixture flowing through the carburetor. This knob is the one on the dash on the passenger side of the car. When the engine is started with the choke closed, a greater vacuum is formed, pulling in a larger amount of fuel.

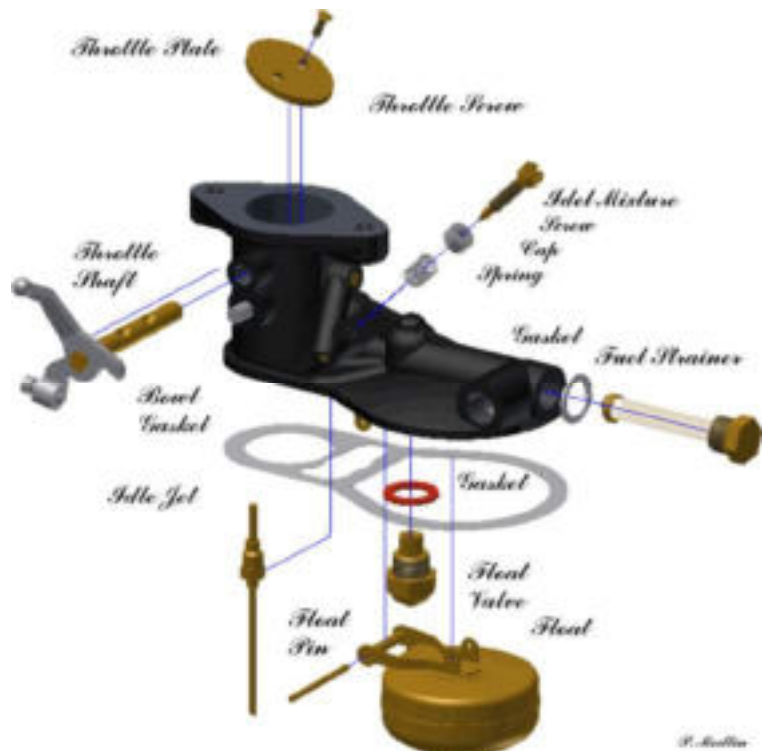
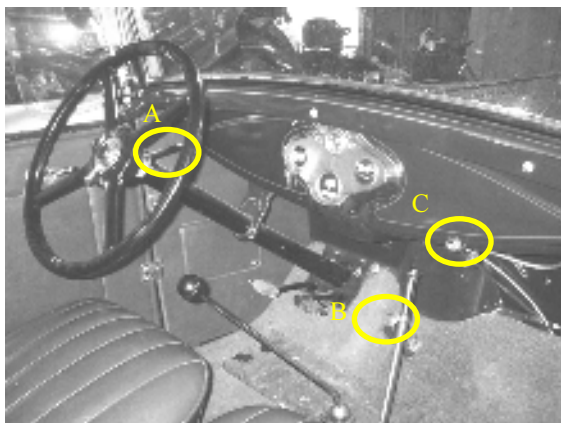

Easter Greetings— From Bunnies and Chicks in antique cars!



An early 1900's prediction!

Six different things: Did you find them all?



This is a picture of a Model A Woody Station Wagon. You can color it any color you want! Have fun!

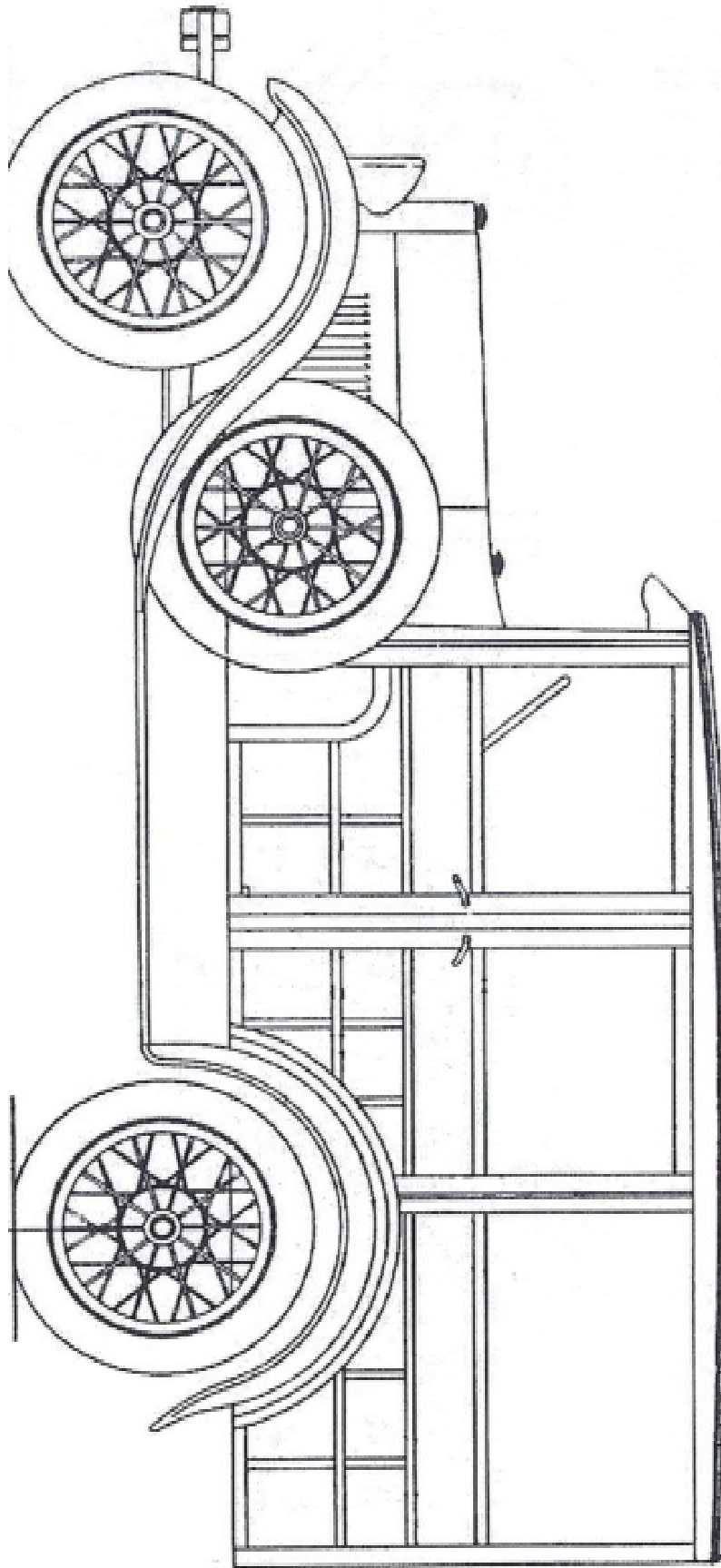



Rumble Seat

Sherry Wink

It's been a long snowy winter where I live, how about your home? I haven't been able to get the Old Lady out all winter. So she's been tucked snug in her side of the garage, just peeking out whenever I open the garage door.

But now that spring is on the way, and I think she and I are getting antsy for a drive. In another week or so, if the transmission tower repair is finished, we'll be on the road for the annual shakedown tour. Hope nothing shakes off!

Please send pictures of you and your cars out enjoying the spring season. I would love to print them on the "Kids and Their A's page. And if you have a story to tell about working on you're A, I'd love to share it in A-World too!



Quiz Time

Take a half sheet of paper. Number 1-10. Name at the top right corner. If you share this A-World with others in your family or friends, make sure you do not write on the newsletter pages. There are two ways to take this quiz: 1) Not looking back 2) Looking back as you take the quiz to find the answers. Try the "not looking" way first!

- 1) What color dye does red cabbage make?
A) Red B) Blue C) Green D) Yellow
- 2) What was in Uncle Pat's tailpipe?
A) Banana B) Chocolate C) Easter Egg
- 3) What magazine was Jasper reading?
A) The Restorer B) Newsweek C) Boys Life
- 4) What is Alexander's sister's name who helped restore their grandpa's Model A?
A) Jill B) Susan C) Emilie
- 5) What soft drink was first sold in 1929?
A) Coke B) 7-Up C) Fanta
- 6) What is Nate's Model A missing?
A) Most of the chassis B) The roof
C) The interior D) All of these
- 7) The Pasadena High School Model A Club is raffling off what year Roadster?
A) 1928 B) 1929 C) 1930 D) 1931
- 8) How many Model A's are shown in the color section of the Model A ad on page 8?
A) 6 B) 10 C) 12
- 9) The throttle plate controls what for the carbonator?
A) gas flow B) exhaust flow C) air flow
- 10) The comic on page 10 predicts what will be the size of dogs by 1951?
A) Cars B) Horses C) Cats

